















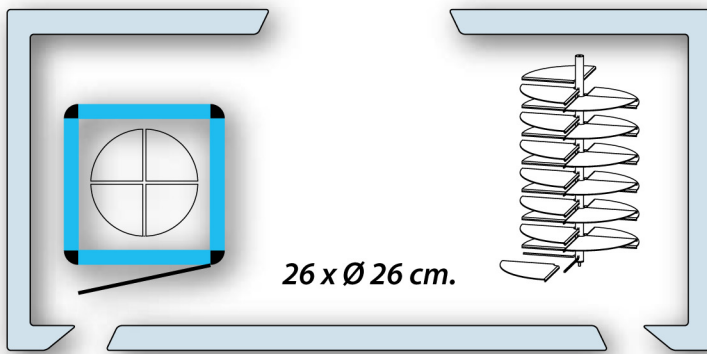



P	+10/+2	1	0,28	530	180 198

					
NFP	+10/-5	1	0,42	530	140 158
NFN	+5/-25	1	0,55	530	150 168



					
P	+10/+2	2	0,96	1260	315 345

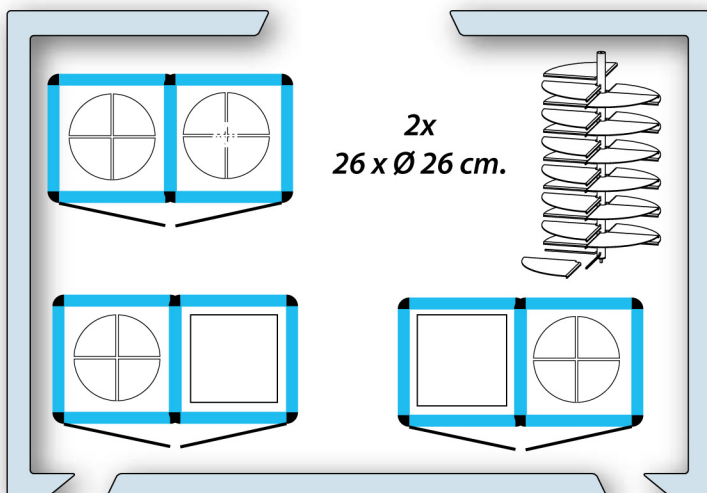





					
NFP	+10/-5	2	1,2	1260	320 350
NFN	+5/-25	2	1,4	1260	330 360
CB	+5/-25; +10/-5	2	1	1260	325 355









R26 LINE

Ripiani girevoli speciali
Special rotating shelves

R26/2 1M

					
P	+10/+2	2	0,8	1270	315 345

					
NFP	+10/-5	2	0,68	1270	320 350
NFN	+5/-25	2	1,2	1270	330 360

